

OUTSIDE DRAWING

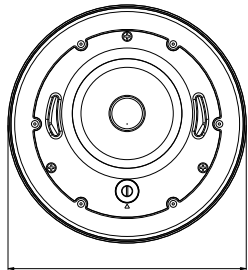

Φ204

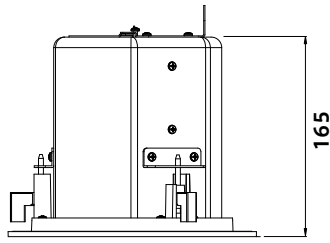
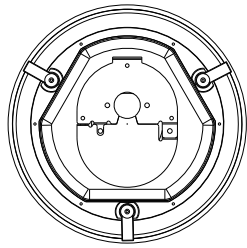

165



Ceiling Speaker

OPERATING MANUAL

MOUNTING SIDE TYPE:

1. Cut a 180mm hole in the ceiling.

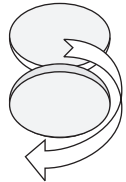

3. Remove the product mesh.

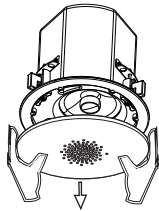

5. Reinstall the net.

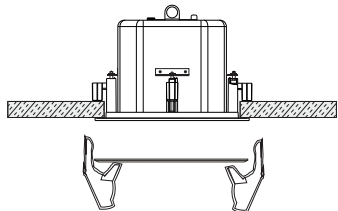

2. Secure the safety rope to the rebar or bolt near the horn opening to prevent the horn from falling.

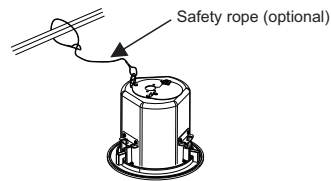

4. Connect the audio signal cable, install the product on the ceiling according to the pre-opened hole, and screw to fix the tongue to the ceiling.

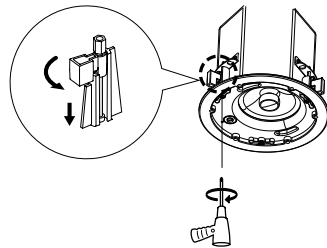

(Appearance is for reference only, see the physical)

Manufacturer: Guangzhou Ruifeng Digital Technology Co., LTD
Address: No. 10, Shiliou Section, Lian Road, Shiliou Town, Panyu District, Guangzhou City

TOP SUCTION SPEAKER SYSTEM

Series application

A place in a store, department store, school, office, hotel, restaurant

Product features

- Extraordinary speech and music reproduction effects
- High strength material housing
- Simple and convenient power setting
- Convenient installation, flexible assembly
- Meet CE standard

Schematic diagram

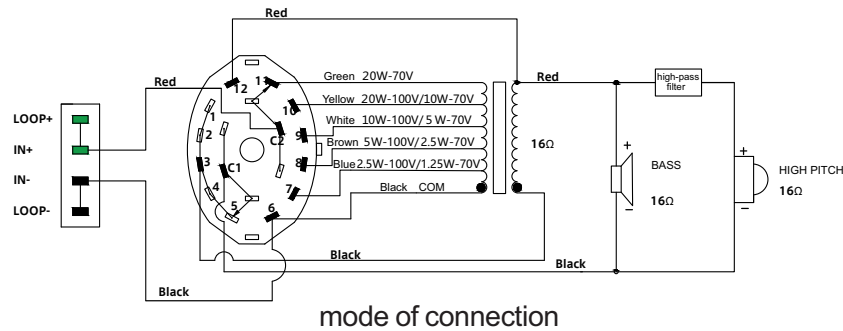

Product curve diagram

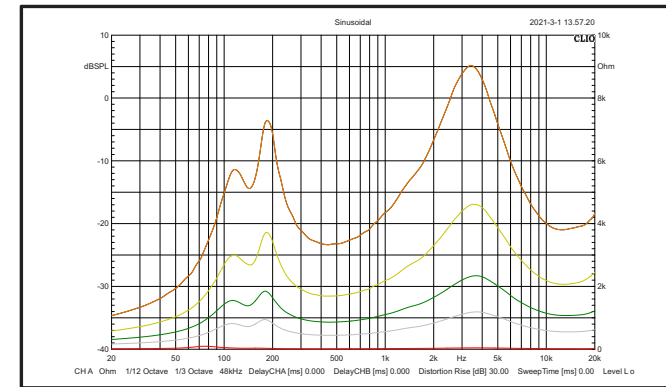
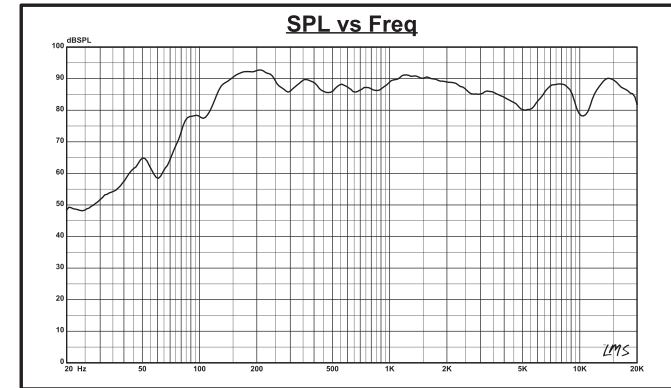

Technical specification

Frequency Response	100Hz ~ 20kHz
Sensitivity (1W/1M)	86dB
Nominal Resistance	4kΩ/2kΩ/1kΩ/500Ω (100V) 4kΩ/2kΩ/1kΩ/500Ω/250Ω (70V)
Rated Power	20W
Power Tap	2.5W/5W/10W/20W(100V) 1.25W/2.5W/5W/10W/20W (70V)
SPL	102dB
Size	Φ204*165mm
Weight	2.09kg

